

# Q5 Electronic Control Manual Book

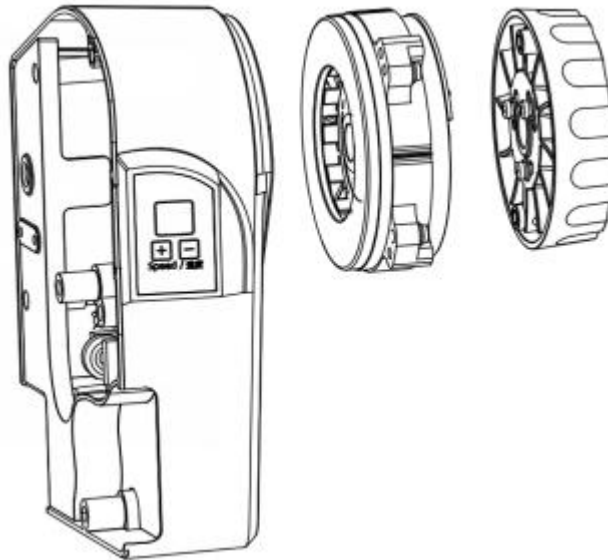

## Preface

GAUTION: PLEASE READ INSTEUCION MANUAL CAREFULLY BEFORE OPERATEING. THE INSTALLATION AND OPERATION MUST BE OPERATED UNDER PROFESSIONAL TRAINED STAFF. This product only applies to the specified rang of sewing equipment, please do not to put other uses.

## SAFETY INSTRUCTION

1. Please read this manual carefully before installation and adjustment.
2. Installation and operation must be operated under professional trained staff.
3. It is not allowed change the structure and any motor parts, otherwise the customer should take full responsibility.
4. Confirm the power connected to the ground safety and keep in accordance with the voltage range and technical requirements in the nameplate.
5. Please leave your feet away from the speed governor when power is turned on or off.
6. You must cut the power off under below mentioned operation:
  - 1) install the machine;
  - 2) Insert or pull out any plug in the control box;
  - 3) Threading, changing needle and rotate the machine head;
  - 4) Machine maintenance and machine is in idle state;
- 7.The setting of control system and maintenance should be operated by trained staff.
- 8.There should be 20seconds separate during changes of power.
- 9.The system must be connected to the ground safety.

## I. Installation of speed governor

Install governor rod should guarantee the rod position is perpendicular to the pedal.  
 Adjustment rod former high and behind low angle to make the pedal angle relative to the ground plane 15 degrees is advisable. (Picture 1 and picture 2 )



Picture 1



Picture 2

## II. OPERATION INSTRUCTION OF OPERATION PANEL

In P interface, the first tube display “P”, the second tube display “-” (means bottom position).

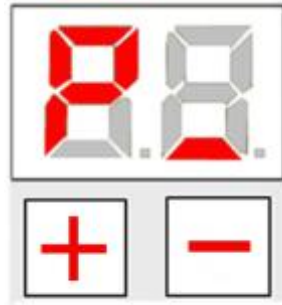

Picture 3

### 1. Parameter Adjustment

#### 1.1 Speed Adjust

The panel shows “P”, then press “+” or “-” to adjust speed up and down. After 3 seconds, the parameter saved the panel back to the “p”. For example, 35 means 3500rpm/min.

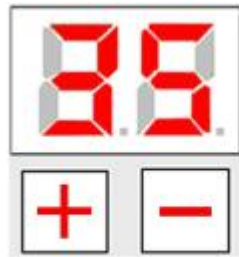

Picture 4: speed interface

#### 1.2 Needle Position Adjust

The panel shows “P”, press “+” for 3 seconds, then set the position up or down.

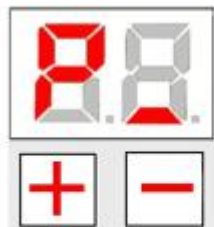

Picture5:bottom position

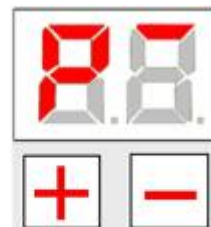

Picture6:up position

#### 1.3 Reset to Factory Defaults Parameter

When the control box cannot work or parameter set abnormal, and panel shows E5/E7 error code, user can reset factory defaults to set.

The panel shows “P”, press “-” for 3 seconds, and the panel shows “OK”, then stop. This means

set successfully. Panel shows “Er” means failure. Check other reasons.

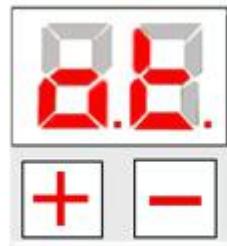

Picture 7 “oK”

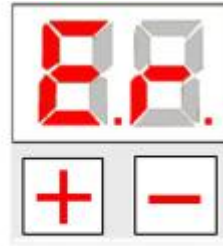

Picture 8 “Er”

#### 1.4 Error Solve with one Button

When the panel shows Err code, machine cannot work, press “+” and adjust which error code. If the Err code still exist, the panel still show the error code. If the problem solved, it will back to P.

### III. OPERATION REPEIREMENTS

1. Please check the control-box far away magnetic or high radiation environment in order to avoid obstructions.
2. The operational temperature must be in the range of  $-5^{\circ}\text{C}$ -- $-40^{\circ}\text{C}$ .
3. Please don't use this product near to any kind of heater (heat, radiator).
4. Please don't use this product in over-wet circumstances.
5. Please don't use this product under the corrosive and explosion situation.
6. Keep ventilation where the control-box and motor stored.
7. Keep the power supply voltage steady.
8. There must be qualified connector to the ground in order to make sure safety.

### IV. MANTAINANCE AND GENERAL RECOVERY PROCESSING

If the machine went wrong, maintenance and operation should be operated under professional trained person.

1. No reaction when turn on the power control box.

Please check if the power plug connected to the socket tightly, or the fuse is burnt, if yes, change the fuse. Open the cover of the control box first, then find the position of fuse, take the burnt fuse out and change a new one which as the same type as before.

2. Control box is connected, but the motor doesn't work when pressing the pedal.

Please check if the plug of the speed controller is connected to the socket in control box correctly. Check the speed controller is broken or not.

3. The motor cannot stop without operate.

Check if the position of magnetic steel coil changed. The method as follow:

Open the speed governor, adjust the position of plastic rocker arm, make sure the magnetic steel coil in rocker arm is just on the hall. Usually, the machine cannot stop running. If the motor still running, user can adjust the rocker arm with clockwise.



**Picture 9 the position when motor stop running**

4. If turn on the machine the fuse immediately burnt, after change the same specification fuse the problem still can't solve, please contact with the local agent to repair.
5. Other problems not list above, please contact with the local agent.

### Error Code List

Error Code	Reasons	Solution
OF	The machine has been in standby mode for about 30 minutes, it goes to sleep mode; the voltage is too low.	Press “+” or “-” to wake up the machine; if still shows “OF”, check the voltage.
E1	Motor stuck The plug of motor loose or drop	Motor used too much. Restart machine after several minutes; Check if the fabric much too heavy; Machine lack of oil; Check if the plug loose or drop.
E2	Motor controller abnormal	1.Usually this problem because the machine too much used or problem of IGBT. If restart without result, contact the agents change. 2.Check the plug loose or drop.
E4	Needle position abnormal	Check if the plug connected well, or the coder wire broken or not, or if the plug loose or shape changed.
E5	Needle governor abnormal	Check the plug connected well; Check if the hall problem. If because hall problem, and shows E5, press “-”for 3 seconds to turn off this function.
E6	Speed governor abnormal	Plug do not connect; Check if the plug connected well, or the coder wire broken or not
E7	Machine head protection of the safety switch	Check the machine head steady or not; Before changing from the agent, user can turn

		off this function by pressing “—” for 3 seconds.
Eb	System over-voltage	Immediately cut off the power, and check whether the supply voltage has exceeded 264V, if yes, please adjust the voltage to the rated voltage, then start to work (rated voltage: 220V) or change parameter “Y” to 0.
Ec	System under-voltage	Immediate cut off the power, and check whether the supply voltage under 154V, if yes, please adjust the voltage to the rated voltage, then start to work (rated voltage: 220V) or change parameter “Y” to 0.

Note: After the system appearing the error, the machine cannot work. The panel continues to display any error code. And the error still can't be eliminated, please contact with the manufacturer in time.